

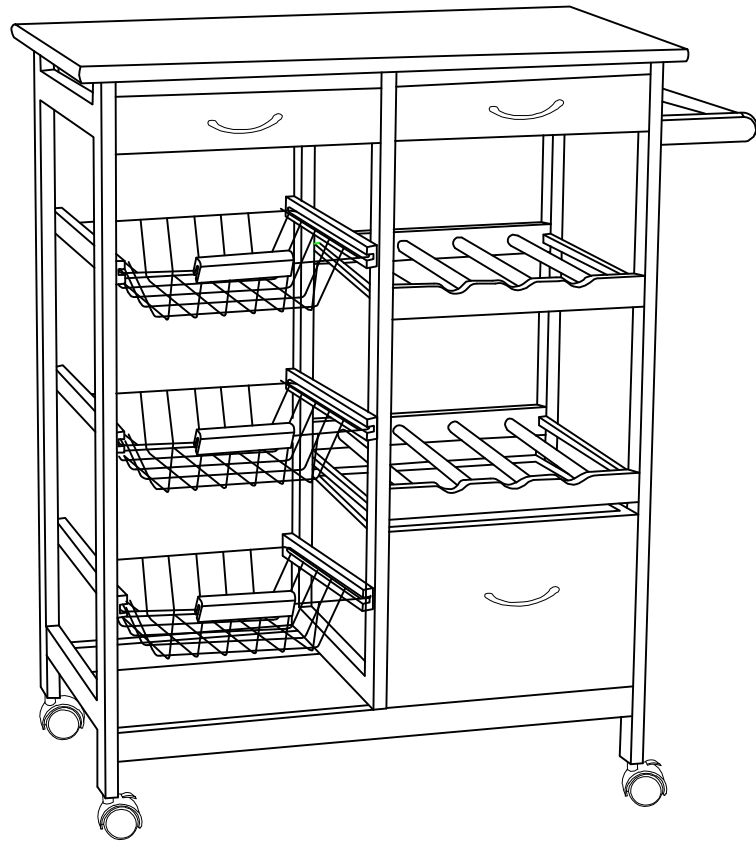

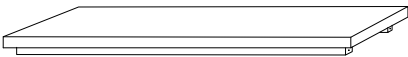

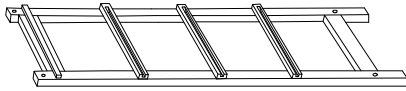

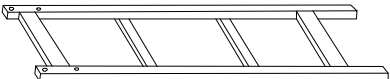

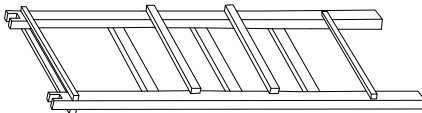

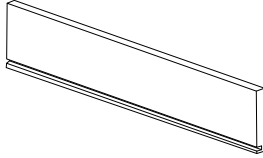
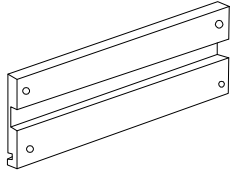
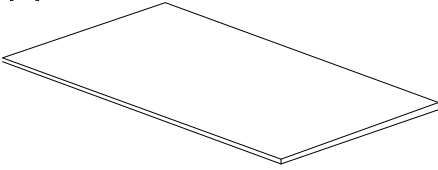
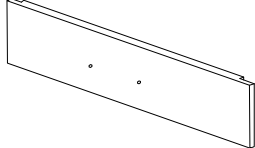
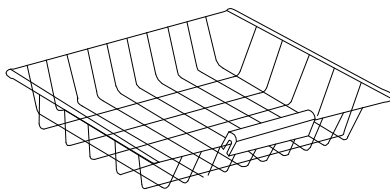
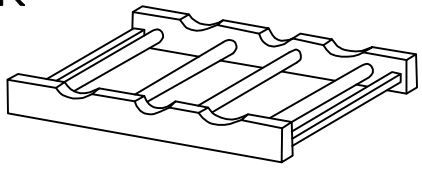
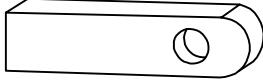
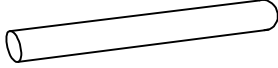
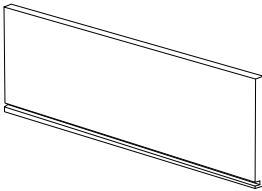
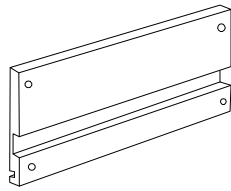
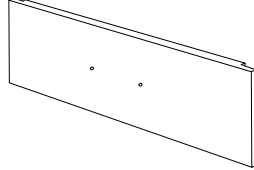
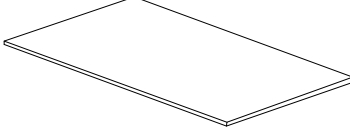
SEMIR

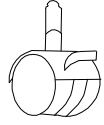
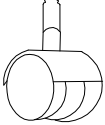
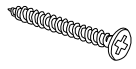
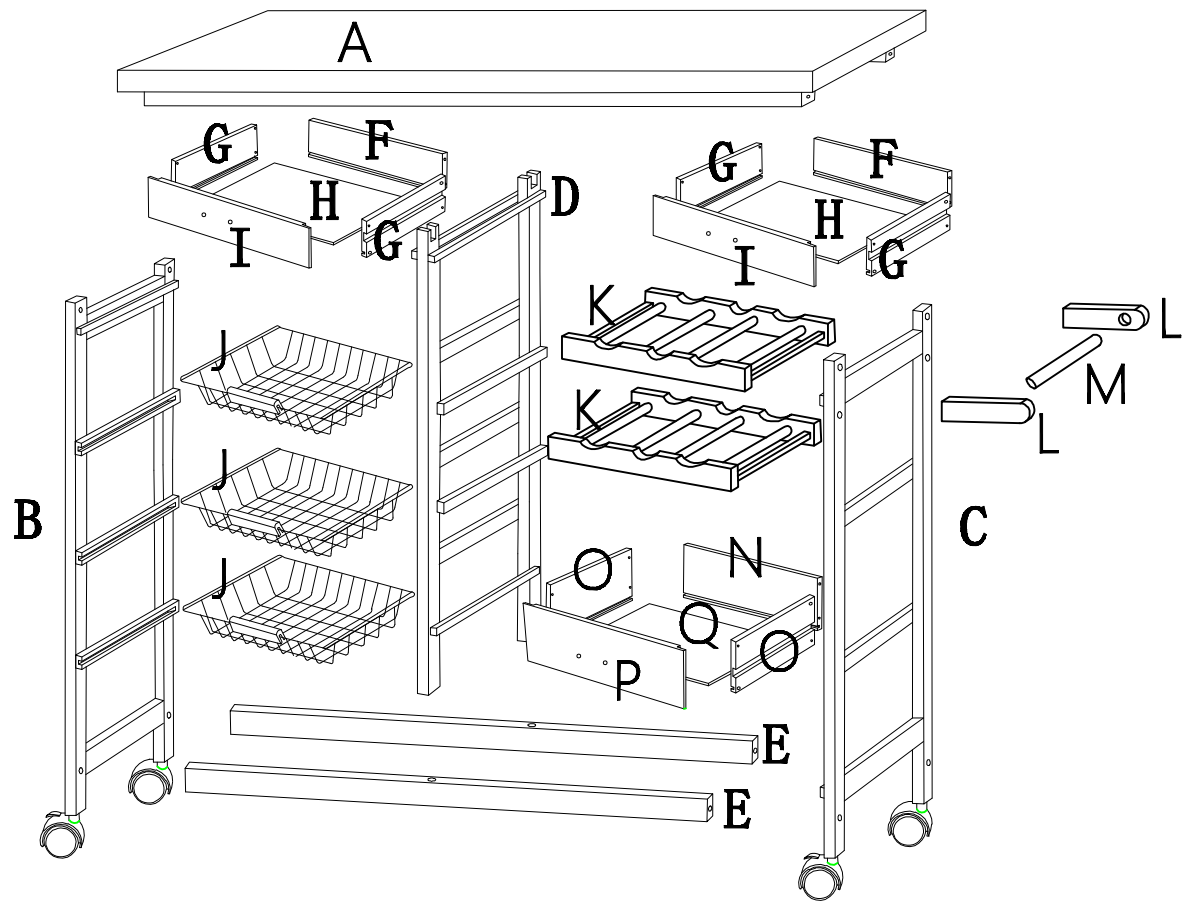

<p>A</p>  <p>x1</p>	<p>B</p>  <p>x1</p>	<p>C</p>  <p>x1</p>
<p>D</p>  <p>x1</p>	<p>E</p>  <p>x2</p>	<p>F</p>  <p>x2</p>
<p>G</p>  <p>x2</p>	<p>H</p>  <p>x2</p>	<p>I</p>  <p>x2</p>
<p>J</p>  <p>x3</p>	<p>K</p>  <p>x2</p>	<p>L</p>  <p>x2</p>
<p>M</p>  <p>x1</p>	<p>N</p>  <p>x1</p>	<p>O</p>  <p>x2</p>
<p>P</p>  <p>x1</p>	<p>Q</p>  <p>x1</p>	

<p>a</p>  <p>x12</p>	<p>b</p>  <p>x3</p>	<p>c</p>  <p>x6</p>	<p>d</p>  <p>x2</p>	<p>e</p>  <p>x2</p>	<p>f 3×25mm</p>  <p>x24</p>
---	---	---	---	---	---



- 1**
- | | | | | | |
|---|-------|---|-------|---|-------|
|  | a x 2 |  | d x 2 |  | e x 2 |
|---|-------|---|-------|---|-------|

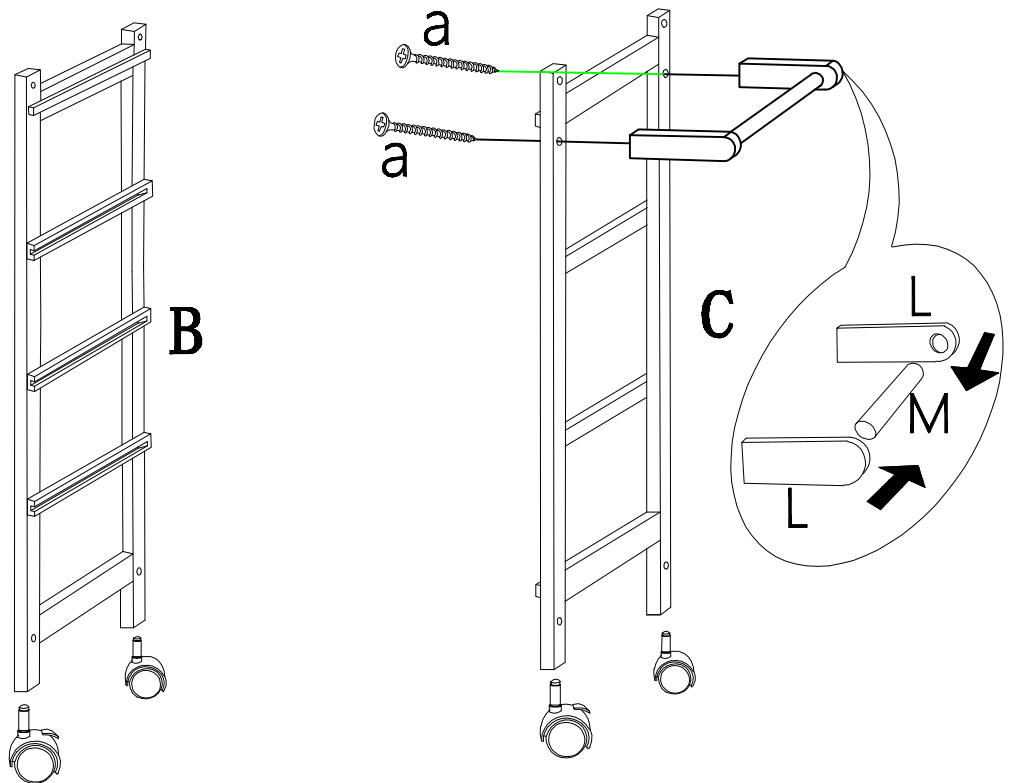

2

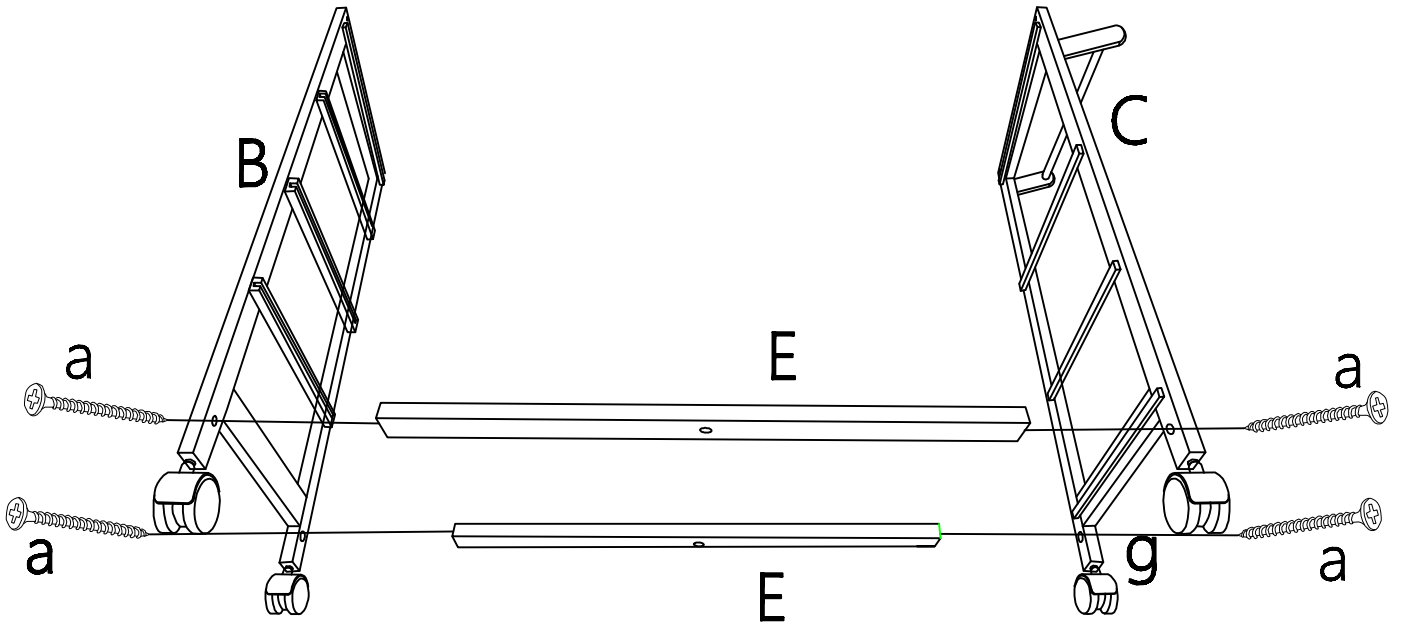
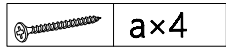

3

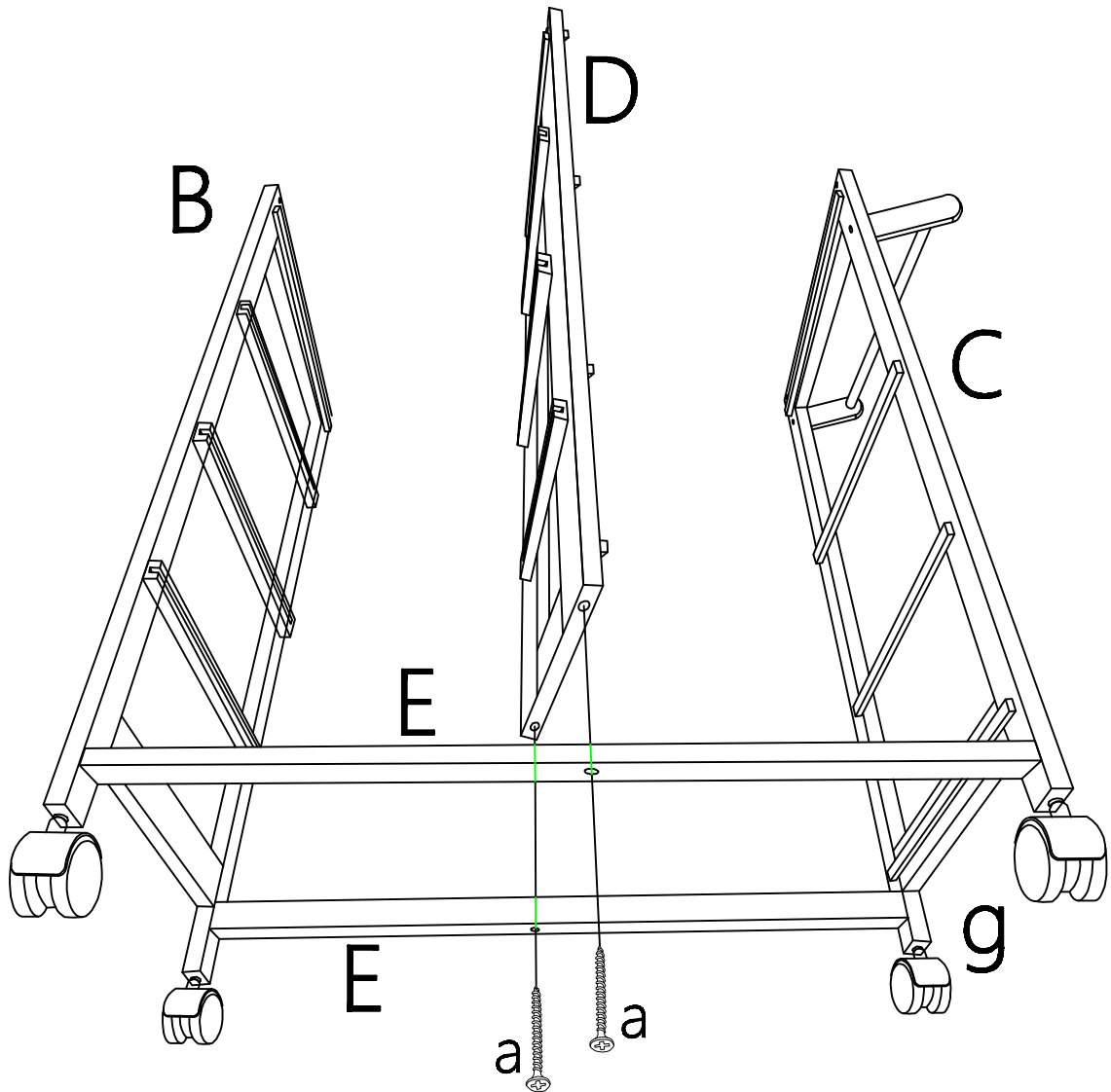
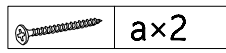

4

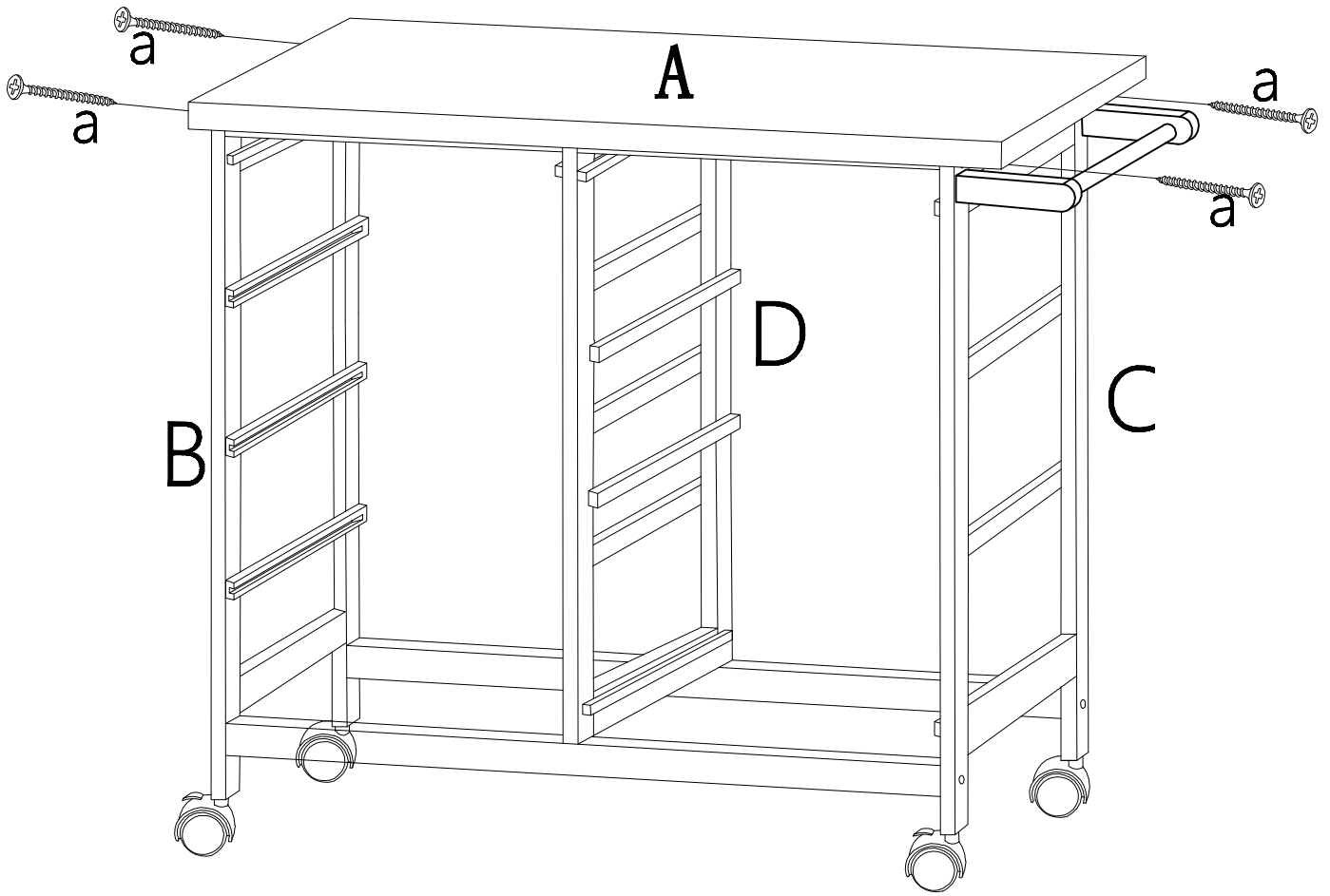
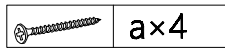

5

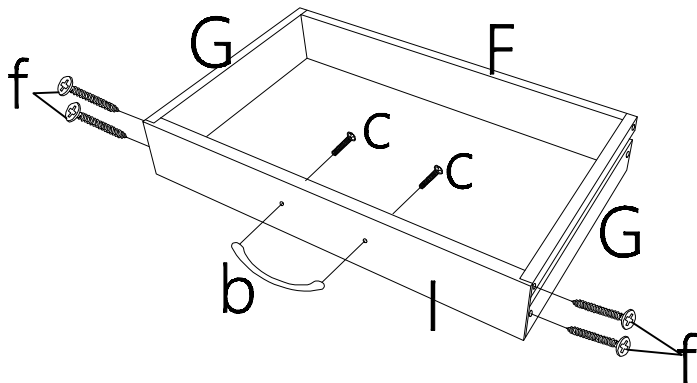
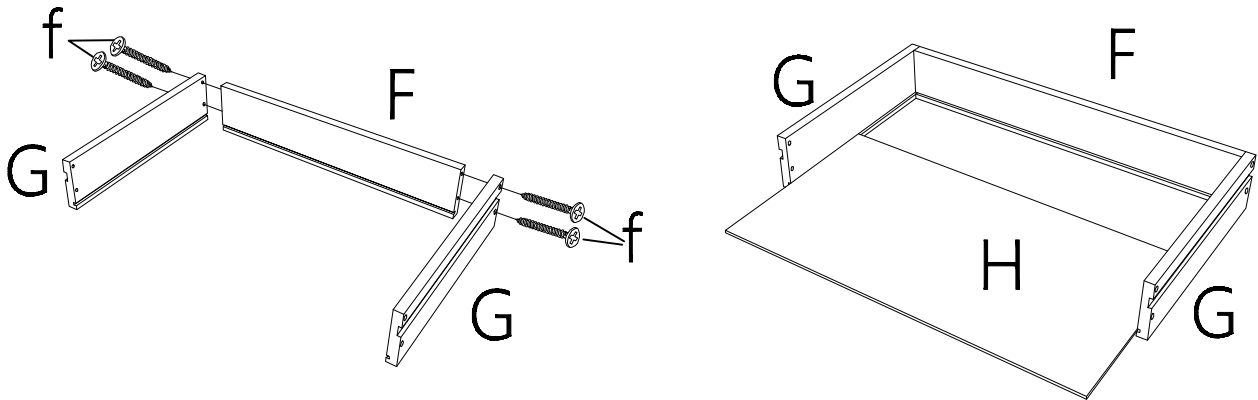
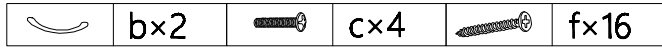

x2

6

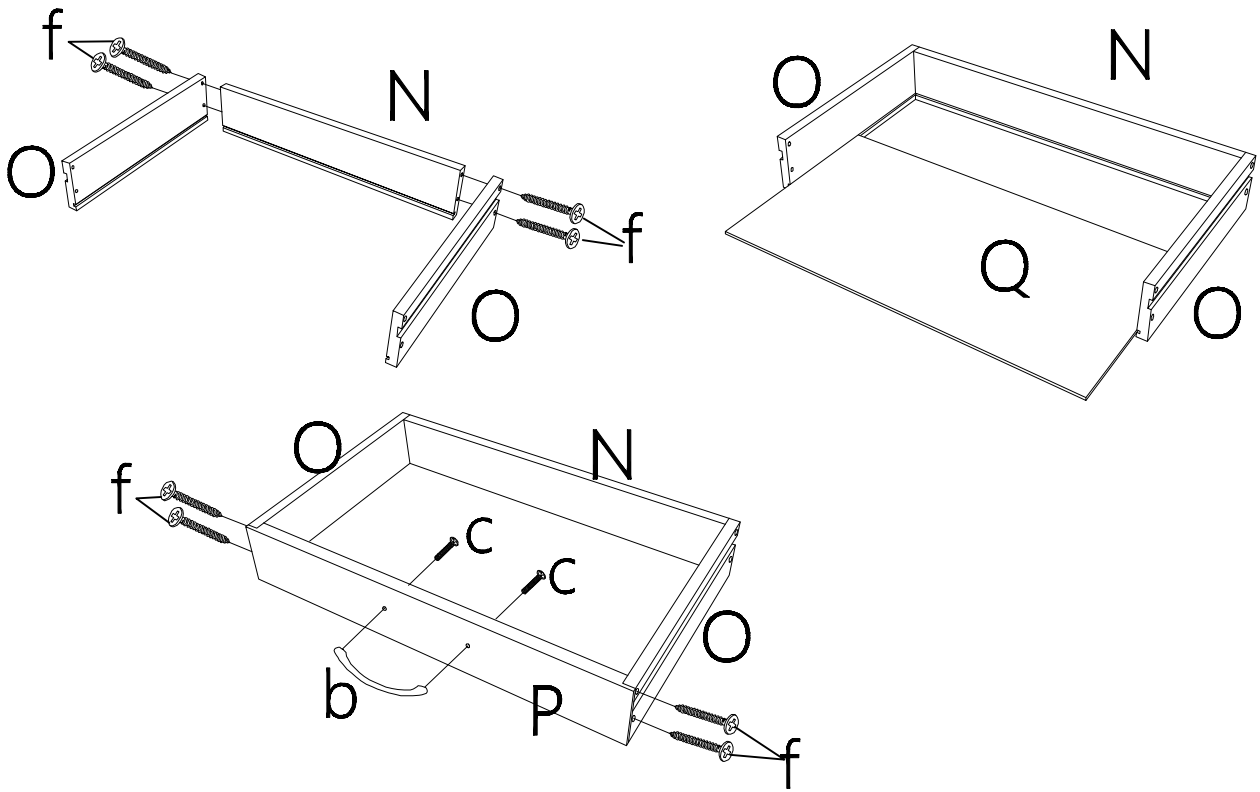
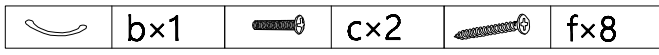

7

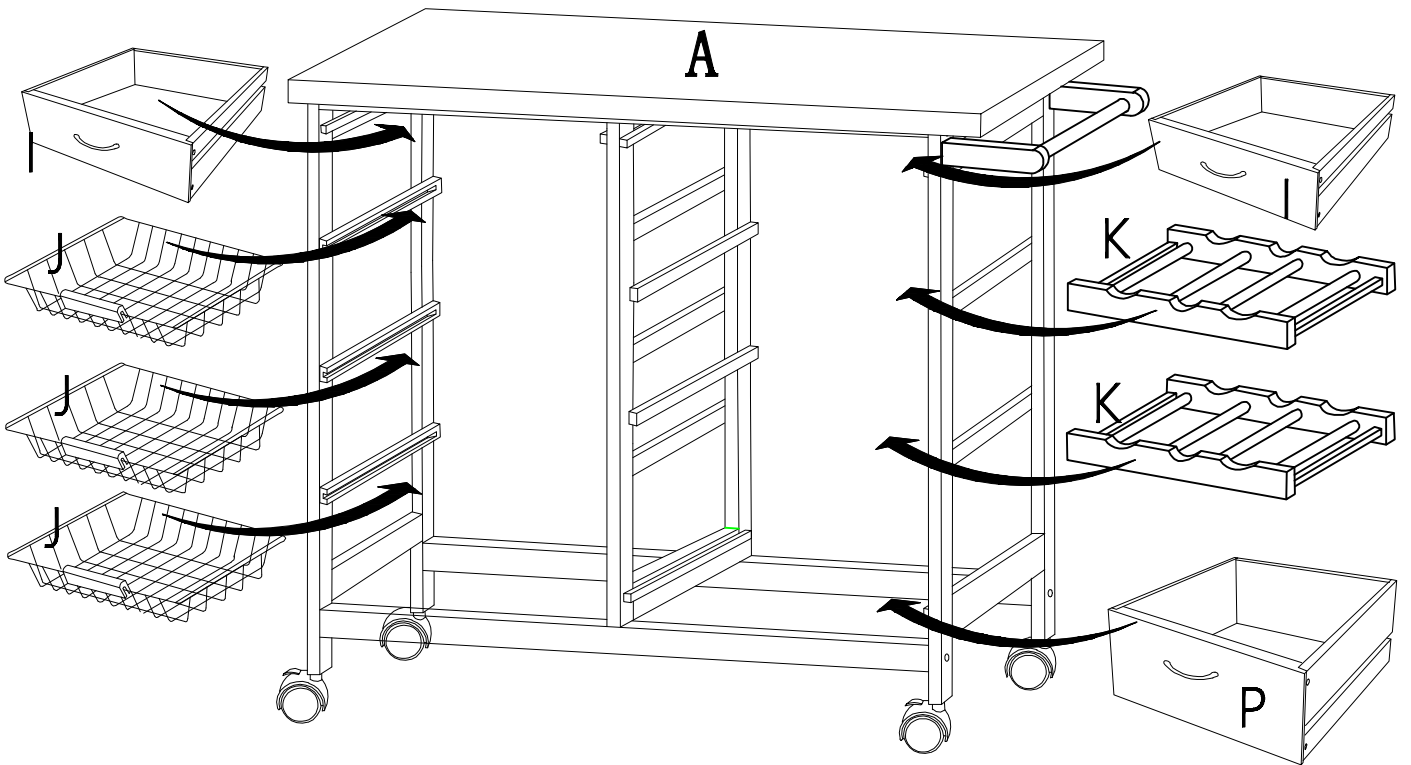

8

